

ifi

NEO STREAM

User Manual



Thank you for purchasing this NEO series Stream. The NEO Stream is an Ultra-Res network audio streamer.

FEATURES:

- Ultra-Res Wi-Fi/LAN/Internet network audio streamer with integrated DAC
- Open-source architecture – works with multiple control apps, evolves continuously
- Stream the way you want – Tidal Connect, Spotify Connect, Roon Ready, AirPlay, DLNA/UPnP, NAA and more
- Supports up to 32-bit/768kHz PCM and DSD512 – not just via USB/LAN cables but Wi-Fi too*
- Full MQA decoding and true-native DSD
- Custom-designed hardware and software – built for exceptional sound
- Fully balanced analogue circuitry delivers maximum sonic purity
- Four user-selectable digital filters – tailor the sound to suit your music
- Exclusive streaming modes – dedicated Tidal, Roon, NAA and DLNA modes for optimised performance
- USB and S/PDIF interfaces are regulated by femto-precision clock to eradicate jitter
- Active Noise Cancellation (ANC) and iPurifier technologies remove distortion from the audio signal
- Optical LAN input isolation technology - superior sound quality over gigabit Ethernet connection
- SilentLine retina-grade TFT screen with album cover artwork display
- Ultra-low noise power supply and optical LAN transmitter/receiver

** Full-strength 5GHz signal is required for playback 384kHz/DSD256 or above over Wi-Fi*

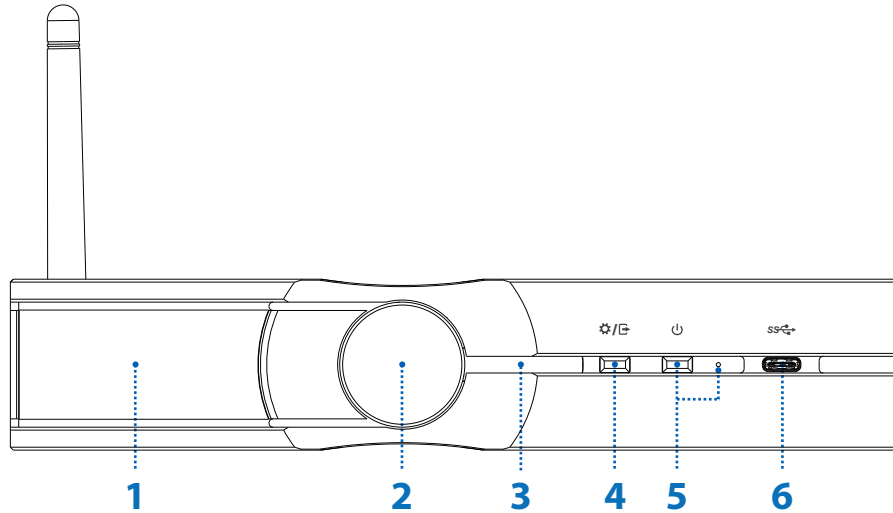

- 1. OLED Display
- 2. Multi-function Knob
- 3. Network Status LED

P.4
P.4-6
P.6

- 4. Menu/Output Selector
- 5. Power Switch And Indicator
- 6. USB-C Input/Output

P.7
P.7
P.7

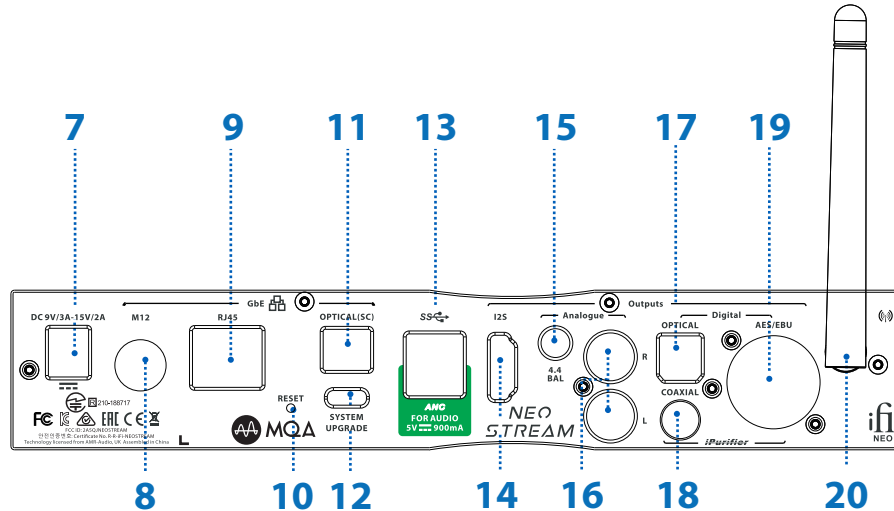

7. DC Power Supply Connection	P.7	12. USB-C System Update Port	P.8	17. S/PDIF Optical Output	P.8
8. M12 Ethernet Input	P.7	13. USB Type A x 2 Ports	P.8	18. S/PDIF Coaxial Output	P.8
9. RJ45 Ethernet Input	P.7	14. I2S Output	P.8	19. AES/EBU (XLR) Signal Outputs	P.9
10. Factory Reset	P.8	15. Balanced 4.4mm Analogue Line Output	P.9	20. Wi-Fi Antenna	P.9
11. Optical Ethernet Input	P.8	16. Single-Ended RCA Line Output	P.9	Quick Start Guide	P.10-13



1. OLED Display

The OLED display shows current playback mode, format, sample rate, and the IP address of the NEO Stream when available.

Tip: OLED screen should be on the left-hand side when NEO Stream is positioned horizontally, and at the top when positioned vertically.

2. Multi-function Knob

Turn for volume control, if enabled.

Turn to select the function to adjust after short-pressing button 4.

- Volume control and Mute (turn the knob/Short press)
- Screen brightness is also selected with a long press of the knob.
- SYSTEM STATUS - displays IP addresses and system version
- Advanced/Simple OLED display
- Audio Output Port Selection – Analogue, Digital, or USB
- System Mode Selector - AIO, DLNA, Tidal Connect, ROON, or NAA
- Hotspot ON/OFF
- Digital Filters

Tip: Turn to select the function to adjust after short-pressing button 4. Short press once to enter the selection, turn knob to make changes, short press again to confirm change.

I) Volume control and Mute

Turn the knob to change the volume. Short press to mute/unmute the sound.

Tip: To enable or disable the volume control, adjust the Playback Options in Settings on <http://ifi.local/>

II) Screen Brightness

long press cycles between:

OFF > Low brightness > High brightness

III) SYSTEM STATUS

Shows Ethernet IP, Host URL, Wi-Fi IP, Hotspot IP, System Version.

IV) Advanced Setting

Simple Displays Ethernet IP and Hotspot URL

Advanced Displays Ethernet IP, Hotspot URL, Wi-Fi IP, Hotspot IP, System Version.

V) Audio Output Port Selection

Choose between Analogue or Digital and USB DAC Audio Output.

VI) System Mode Selector

The following 5 play modes can be selected:

- AIO (All-In-One). Required for accessing configuration pages from web browser, e.g. <http://ifi.local>
- DLNA only
- TIDAL Connect only
- ROON only
- NAA (Network Audio Adapter) only



VII) Hotspot Selection

Turns the Hotspot on / off. After resetting, by default it will open for 1 minute and then close automatically.

Tip: NEO Stream's hotspot has no external network functionality and is only used to connect the phone to the NEO Stream setup network.

VIII) Digital Filters

The following 4 digital filters are available:

- 'BP' Bit-Perfect: no digital filtering, no pre or post ringing
- 'STD' Standard, modest filtering, modest pre and post ringing
- 'MIN' Minimum phase, slow roll-off, minimum pre and post ringing
- 'GTO' Gibbs Transient-Optimised: up-sampled to 352.8/384kHz, minimum filtering, no pre ringing, minimum post ringing

Note: If the GTO filter is selected, the display indicates the sample rate as 352.8kHz or 384kHz, illustrating the upsampling operation of this filter.

3. Network Status LED

	LED	Speed
Internet	White	Fast
Internet	Cyan	Slow
Local network (no Internet)	Green	Fast
Local network (no Internet)	Yellow	Slow
No connection	Red	-

4. Menu/Output Selector

Short press: Displays the current digital filter set. To change the digital filter, press the knob to enable selection, turn to change the filter, and press the knob again to confirm. Please see item 2, VIII.

Long press: Displays the output setting. Choose between Analogue, Digital, or USB DAC audio (if connected) by turning the knob, and press the knob again to confirm.

5. Power Switch And Indicator

Short press to switch on, long press $\geq 2s$ to switch off.

6. USB-C Input/Output

a) Output - Connect to USB DAC

b) Input - Connect to HDD, USB DISK etc.

Tip: The USB-C connector has Active Noise Cancellation (ANC) technology built-in.

7. DC Power Supply Connection

DC 9V/2.0A, 12V/1.8A, 15V/1.2A* power input. Please connect NEO Stream to the enclosed power supply.

**A power supply unit must be able to deliver minimum rated repetitive current.*

8. M12 Ethernet Input

Connect a network cable with an M12 X-code 8-pin connector.

9. RJ45 Ethernet Input

Connect a wired network cable with a RJ45 connector.



10. Factory Reset

Long press ≥ 3 seconds, wait 3 minutes and the screen will appear with the ifi logo.

DO NOT POWER OFF!

Warning: Loss of power during this period may damage your device and leave it unusable.

11. Optical Ethernet Input

Connect with an SC single mode optical network cable.

Alternatively connect the included OptiBox RJ45 to optical transceiver with the SC-SC cable.

12. USB-C System Update Port

Used for system firmware update (by factory).

13. USB Type A x 2 Ports

Compatible with USB 2.0 and USB 3.0.

a) Output - Connect to USB DAC

b) Input - Connect to HDD, USB DISK etc.

Both USB ports have Active Noise Cancellation (ANC) technology built-in.

14. I2S Output

I2S digital output via HDMI connector. Connects to a compatible DAC. The level complies with the low voltage differential signal (LVDS) standard. For the pinout, please see Specifications.

15. Balanced 4.4mm Analogue Line Output

Connection of 4.4mm to XLR or similarly balanced interconnects.

16. Single-Ended RCA Line Output

Connect analogue RCA interconnects to an amplifier.

17. S/PDIF Optical Output*

This is an S/PDIF TOSLINK signal output.

18. S/PDIF Coaxial Output*

This is an S/PDIF RCA signal output.

**Tip: S/PDIF standard supports PCM sample rates up to 192kHz.*

19. AES/EBU (XLR) Signal Output

AES/EBU (XLR) balanced digital signal output.

20. Wi-Fi Antenna

Please attach the enclosed antenna for best wireless connection.



Quick Start Guide

Short press: Menu
Long press: Output Selector

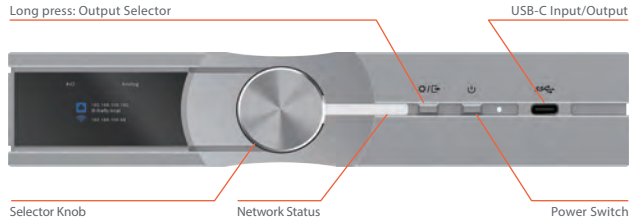

1 Power

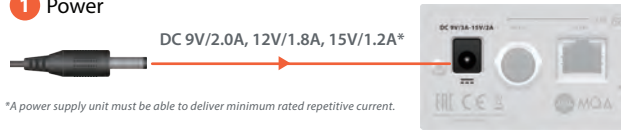

2 Input

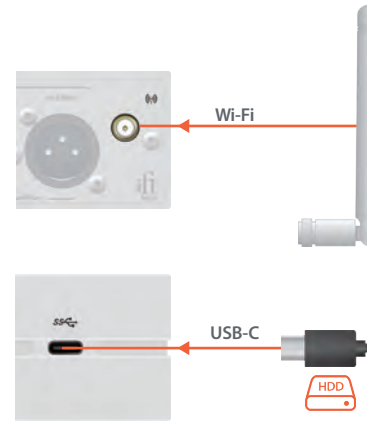
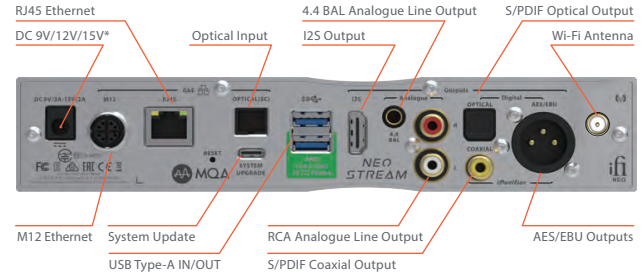
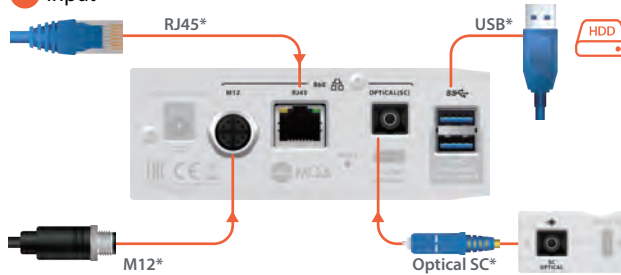

3 Output

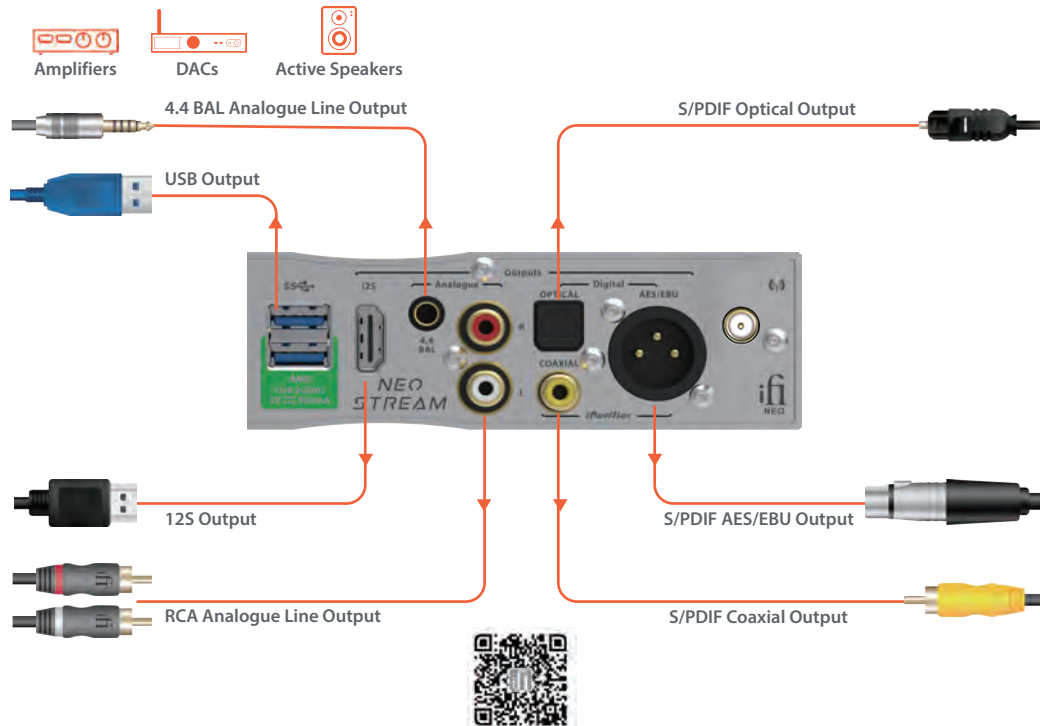

Before using NEO Stream, review the NEO Stream User Manual at <https://ifi-audio.com/product-guides/>



Ethernet Set-Up

- 1 Connect LAN and power supply
DAC, Amplifier or Active Speakers via S/PDIF, RCA or USB

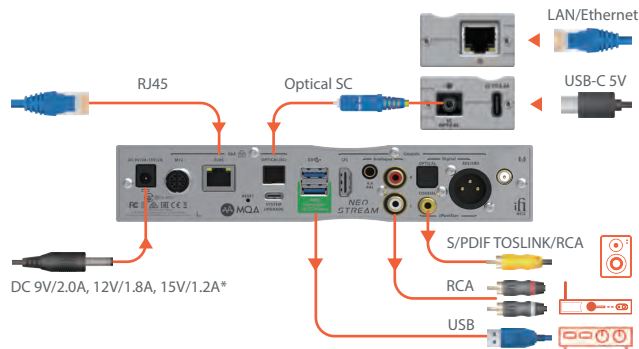

*A power supply unit must be able to deliver minimum rated repetitive current.

- 2 Power on



- 3 Ready to connect

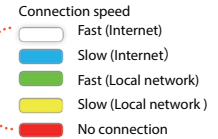

- 4 IP address will show once connected



Music Streaming



Open Tidal app

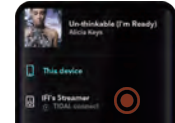
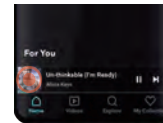

Other compatible apps are available

Wi-Fi Set-Up

- 1 Connect Wi-Fi antenna and power supply DAC, Amplifier or Active Speakers via S/PDIF, RCA or USB

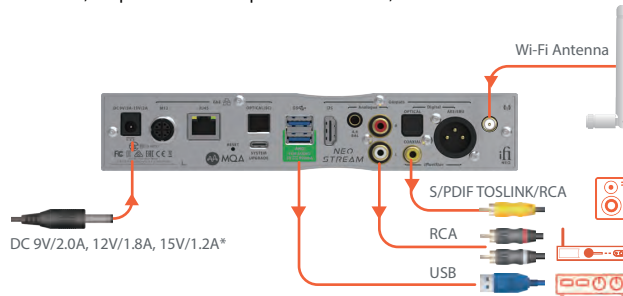

*A power supply unit must be able to deliver minimum rated repetitive current.

- 2 Power on



- 3 Select Hotspot and set to ON



- 4 In your device's Wi-Fi setting, connect to 'iFi-Streamer'



- 5 iOS Enter "http://ifi.local" or "192.168.211.1"
Android Enter "192.168.211.1"



- 6 Connect the iFi-Streamer to your local Wi-Fi network



Enter network password and press Connect



IP address will show once connected

- 7 Network status LED

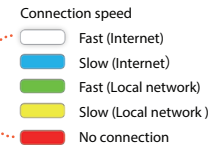

- 8 Connect device back to local Wi-Fi network (If not already connected)

- 9 Go to Music Streaming section



MQA

NEO Stream includes MQA technology, which enables you to play back MQA audio files and streams, delivering the sound of the original master recording.



'MQA' or 'MQA.' indicates that the product is decoding and playing an MQA stream or file, and denotes provenance to ensure that the sound is identical to that of the source material. 'MQA.' indicates it is playing an MQA Studio file, which has either been approved in the studio by the artist/producer or has been verified by the copyright owner. 'OFS' confirms that the product is receiving an MQA stream or file. This delivers the final unfold of the MQA file and displays the original sample rate.

MQA and the Sound Wave Device are registered trade marks of MQA Limited © 2016

MQA

- 1) Listen to MQA (Master Quality Authenticated) files straight out of the box.
- 2) For MQA tracks, simply connect to Tidal and check the options to stream MQA.
- 3) Visit mqa.co.uk for more information.

Specifications

Inputs:

Wi-Fi
 Ethernet (M12 X-code 8-pin/RJ45/Optical)
 USB-A and USB-C (front panel) (USB DISK, HDD etc.)

Formats:

DSD: up to 512 / 22.6MHz
 PCM: up to 768kHz
 MQA Full Decoder

Analogue output:

Balanced 4.4mm 4V RMS / UnBAL RCA 2V RMS

Digital output:

USB-C (front panel)
 USB3.0 Type-A Socket x2 (USB2.0 compatible)
 S/PDIF Optical (PCM up to 192kHz, 24-bit)
 S/PDIF Coaxial (PCM up to 192kHz, 24-bit)
 AES/EBU (XLR - single link, PCM up to 192kHz)
 I2S via HDMI connector
 Pinout: 1) Data - 2) Gnd 3) Data +
 4) Bck + 5) Gnd 6) Bck -
 7) Wck - 8) Gnd 9) Wck +
 10) Mck + 11) Gnd 12) Mck -
 13,14,15,16) DSD Enable; L=PCM, H=DSD
 17) Gnd 18) 5V Power Enable Output; L=Off, H=On
 19) N/C 20,21,22,23) Gnd



Output Impedance:

Balanced $\leq 74\Omega$

UnBAL $\leq 37\Omega$

SNR: $< -106\text{dB(A)}$ @ 0dBFS (BAL/UnBAL)

THD + N: $< 0.0025\%$ @ 0dBFS (BAL/UnBAL)

Power supply requirement: DC 9V/2.0A, 12V/1.8A, 15V/1.2A* (centre pin +)

Power consumption: $< 0.5\text{W}$ idle, 14W max.

Dimensions: 214 x 151 x 41 mm (8.4" x 5.9" x 1.6")

Net weight: 1.0 kg (2.26 lbs)

Limited Warranty: 12 months**

**A power supply unit must be able to deliver minimum rated repetitive current*

***12 months typical or as permitted/required by local reseller laws.*

****Specifications are subject to change without notice.*

ifi